



Light Mask Product Manual



Introduction

Congratulations on your purchase of an Equilume Light Mask. We hope that you and your horse will enjoy the many benefits that this innovative product offers.

Horse owners and breeders around the world are enjoying the freedom and flexibility that mobile, precision blue lighting offers for improving breeding efficiency, coat condition and performance. Whether you are looking for success in the show-ring or the breeding barn, the Equilume team are here to support you on your journey.

This product manual leads you through the simple steps for use, care and maintenance of your Equilume Light Mask. Please read it carefully.

Manual Index

- 3: Product summary
 - > Belfield
 - > Curragh
 - > Cashel
- 4: How to activate and deactivate/reset
- 5: How to fit the mask
- 6: Maintenance
- 7: Components
- 8: How to replace the cup
- 9: How to recharge the cup
- 10: Customer support
- 11: Product support
- 12: Product warranty
- 13: Contact us

Product Summary

Belfield

This mask is for seasonal use and has a limited lifespan

- > Battery lifespan: **5 months**
- > Active hours per day: **7**
- > Activation time: **4pm**

Curragh

This mask allows replacement of the cup when the battery has expired

- > Battery lifespan: **4 months**
- > Active hours per day: **7**
- > Activation time: **4pm**

Cashel

This mask has a rechargeable and replaceable cup and it is ideal for horses with limited turn-out and/or poorly lit stables

- > Battery lifespan: **12 months**
- > Active hours per day: **15**
- > Activation time: **8am**
- > Active time between charges: **7 days**
- > Recharge time: **3-4 hours**

How to activate and deactivate/reset

Activate

The mask can be activated before fitting it on the horse. The mask only needs to be activated once. Slowly wave the Equilume Smart Key across the cup surface several times. This should be done at the **activation time** indicated on the product summary page.

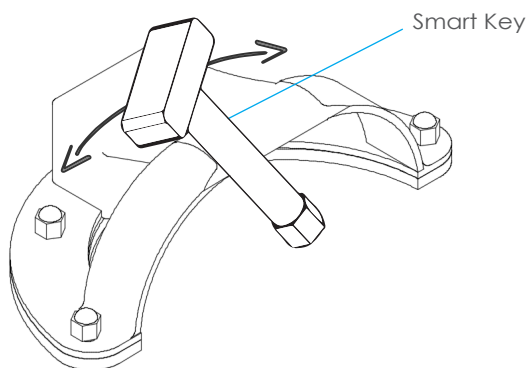

Observe that the blue light turns on. Once activated initially the Equilume Light Mask will automatically turn on at that time everyday and remain on until the pre-programmed light duration is reached.

Deactivate/ Reset

To deactivate the Equilume Light Mask, wave the Equilume Activator Wand or Equilume Smart Key across the cup surface slowly several times. To reset, follow the activation instructions above.

How to fit the mask



Step 1

Open the velcro below the jaw piece and hold the Light Mask by the headpiece.

Please ensure that the horse is familiar with the velcro sound before fitting the mask to avoid alarming the horse.

Fit the mask over the ears, as you would a bridle.



Step 2

Close the velcro below the jaw; be sure the mask is secure but not too tight.

Straighten the mask on the face and position the mane and forelock.

Adjust the mask to fit each individual horse via the velcro fastenings at the side and centre.



Step 3

Please ensure the eye openings are centred around the eyes.

If required, fit the halter over the Light Mask, threading the head strap through the halter retaining loops, which are situated on the head strap.

Maintenance

Step 1

The light intensity will be maintained by cleaning the inner surface of the cup once per week with a damp cloth.

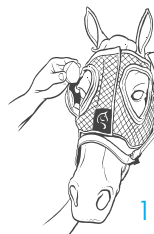

Step 2

You should inspect the fit and positioning of the light mask on your horse weekly to ensure optimum comfort and function.



Step 3

You should groom the horse's head before fitting and after each week of use to facilitate hair shedding.



Step 4

If required, it is recommended that the halter retaining loops should be used to stabilise and position the mask correctly.

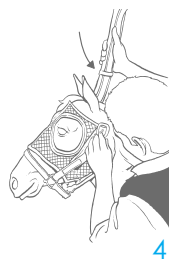

Step 5

All Equilume Light Masks have time sensitive activations. Your light mask should be activated once at the **designated time** as indicated in the product summary for the specific model.

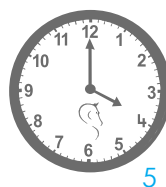

Components

Curragh/Cashel Cup Assembly

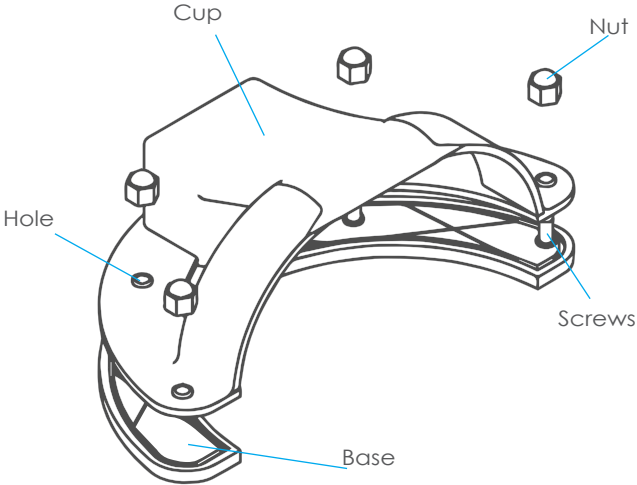

Smart Key

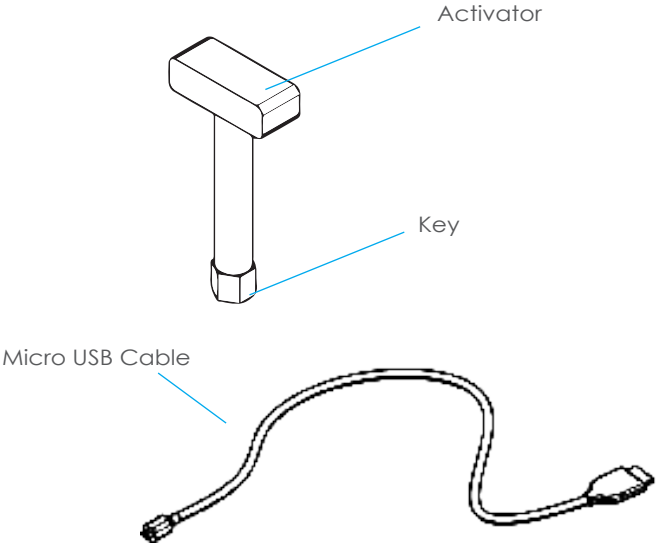

How to replace the cup (Curragh and Cashel Models)

1

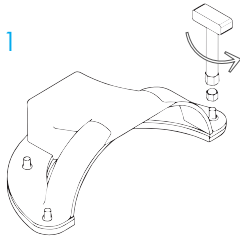

Step 1:

Remove the nuts from outside of the expired cup by attaching the Smart Key socket and turning it anti-clockwise.

2

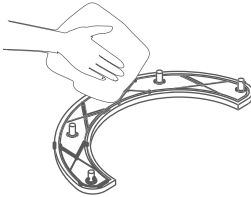

Step 2:

Remove the dirt and debris from around the screws using a damp cloth.

Step 3:

Line up the cup holes with the screws in the base, press down gently until in place.

3-5

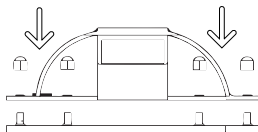

Step 4:

Attach a new nut to the end of each screw, lightly turn them clockwise.

Step 5:

Tighten the nuts using the Smart Key by turning it clockwise.

6

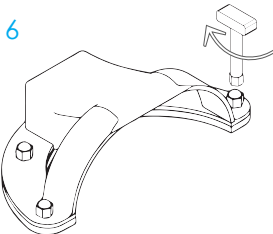

Step 6:

Examine that the new cup is attached securely and activate it using the Smart Key at the designated time according to instructions.

How to recharge the cup (Cashel model)

1

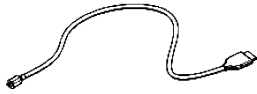

On opening your new cup, please charge before use as follows:

Step 1: Connect the USB cable to the universal power adapter and plug in the adaptor to a suitable electrical outlet.

2

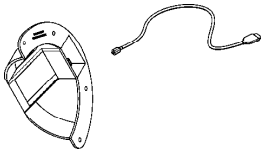

Step 2: Connect the micro end of the USB cable to the charging port on the underside of the cup.

Step 3: The cup will show a red flashing light when charging.

4

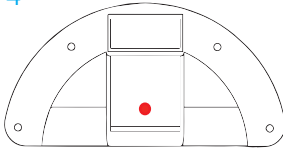

Step 4: A full charge will take between 3 and 4 hours. The red flashing light will turn to a solid red light, once the cup is fully charged.

Step 5: Using the Smart Key, check that the nuts are tight and that the cup is still attached securely to the base.

5

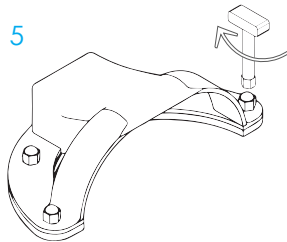

Step 6: Activate the cup at 8am using the Smart Key after the first charge. If subsequent recharges are completed within 24 hours of the battery having expired, re-activation at 8 am is not required.

Step 7: After 7 days of continuous use the cup **must** be recharged within 24 hours. **If the battery becomes completely flat this may result in the timer losing its memory. If this happens you will need to reactivate the cup at the designated time.**

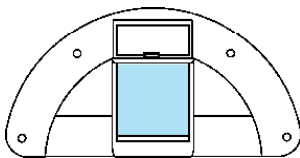

Note: When charging the cup it is recommended to leave the cup attached to the mask, unless you are alternating between more than 1 cup. If you need to remove the cup please follow "how to replace the cup" instructions.

Customer support

Technical support

If you are experiencing any technical difficulties with your Equilume Light Mask, our customer service team are on hand to help and talk you through resolving the issue.

Email info@equilume.com or contact one of our territory managers.

Application support

The Equilume Light Masks can be used for a wide range of applications from coat conditioning, improving breeding efficiency, enhancing performance etc.

If you have any questions or queries about any of these applications you can contact a local Equilume representative or email us directly at info@equilume.com. We offer tailored individual programs and consultations to all of our direct customers.

Product support

If you are experiencing any issues with your Light Mask, it is recommended that you reset the mask by using your Equilume Activator Wand or the Equilume Smart Key at the appropriate time before contacting our customer service team. This will be the first task our team will ask you to do.

What to do if.....?

The light on my mask is coming on at a different time than originally scheduled?

There may have been some interference with the timer during the active hours of the mask. You should de-activate, wait 30 seconds and then re-activate your mask at the designated time indicated in the product manual or on our website **www.equilume.com**

My Cashel cup did not hold its charge for 7 days on the first use?

As indicated in the product manual, the Cashel cup will need a full charge before initial use after purchase.

I want to recycle my used mask?

The Equilume Light Mask can be recycled. However, it needs to be recycled through an e-waste company due to the lithium ion battery.

A component of my mask is damaged or broken from use?

All individual components of the masks can be purchased separately by contacting the Equilume team via email at **info@equilume.com**

Product warranty

The Equilume warranty is active from the date of purchase. The warranty covers any electronic failures associated with the cup. The headpiece is not covered under warranty. To register your warranty please email warranty@equilume.com. You will receive a link that will take you to the warranty registration form.

Length of warranty (from date of purchase):

- > Belfield: 90 days
- > Curragh: 90 days
- > Cashel: 6 months

Please note: Any reported faults may not be accepted unless your warranty has been registered.

Contact us

W1G Ladytown Business Park,
Naas,
Co Kildare
W91 TP22
Ireland

Ph: +353 45 40 7040

info@equilume.com

www.equilume.com



